

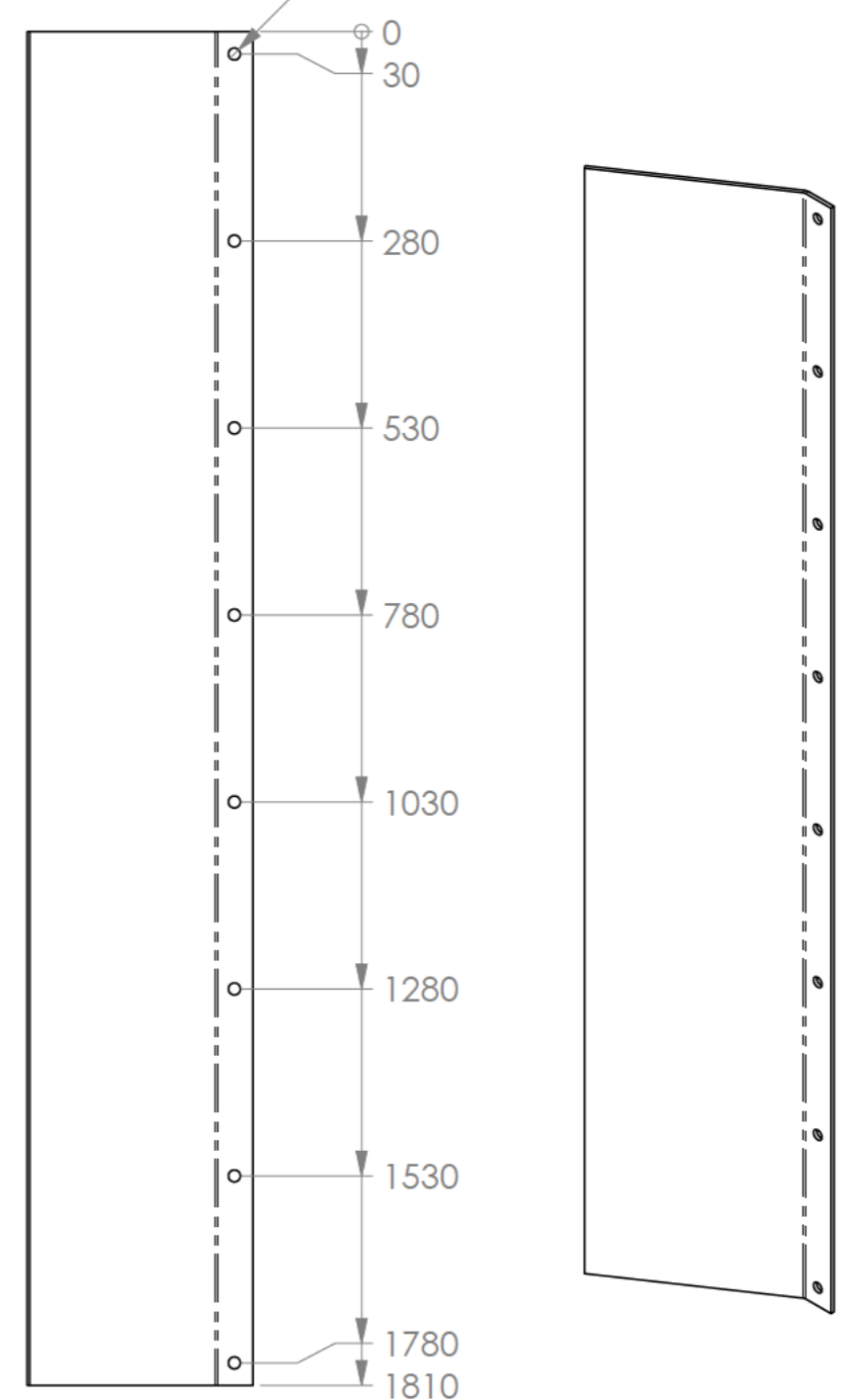

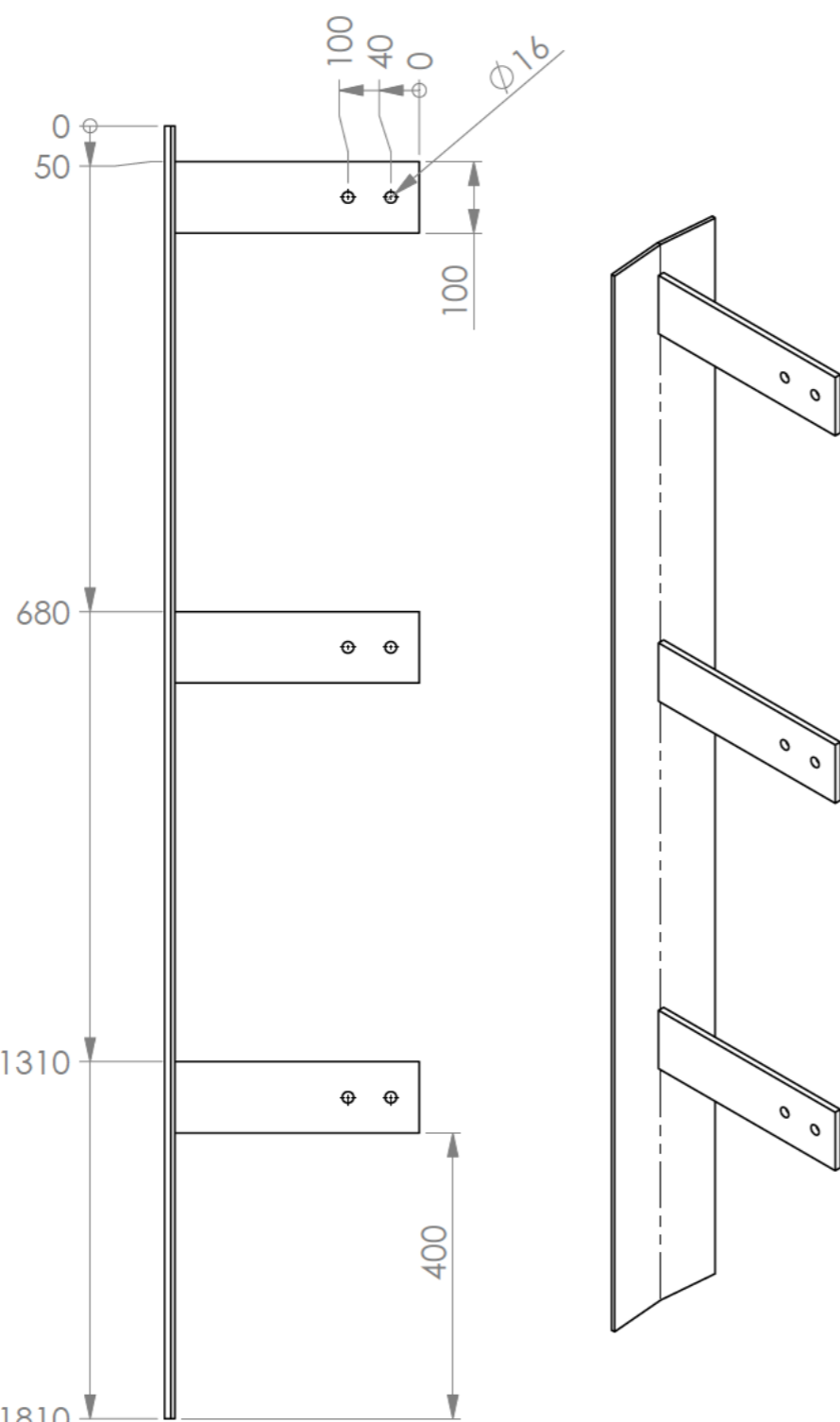

1X

1X

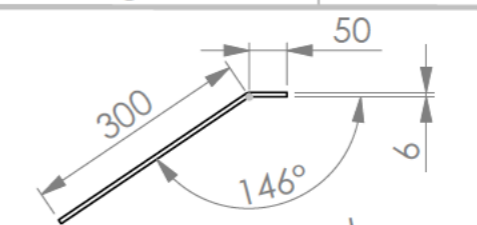
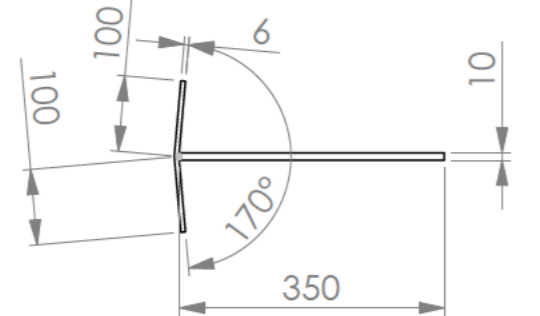

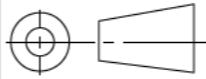
AANTAL:		OPMERKING:		 Sylsterwei 8 9132 EK Engwierum Tel. 0511 - 408 232 info@miedema-metaal.nl www.miedema-metaal.nl	
AM.PROJECTIE  Third Angle		SCHAAL: 1:10	MATERIAAL: RVS304		
TEKENINGNR: 240694.1		MAATEENHEID: mm	PROJECT:	KLANT: Vegter Waterbouw BV	
		DATUM: 7-11-2024	GETEKEND: 	Deze tekening blijft eigendom van Miedema Metaal en mag zonder schriftelijke toestemming niet worden gekopieerd, noch aan derden worden verstrekt of ter inzage worden gegeven.	
		REVISIE:	BESCHRIJVING: Hoekstukken Kantens	Blad 1 van 1	
				A3	